

**HSF**

PIN	SEGMENT
1	NC
2	CSB
3	RST
4	A0
5	SCL
6	SDA
7	VDD
8	VSS
9	VG
10	VG
11	VO
12	XV0
13	NC
14	NC
15	NC
16	NC
17	NC
18	NC
19	NC
20	NC

VIEWING DIRECTION 12:00

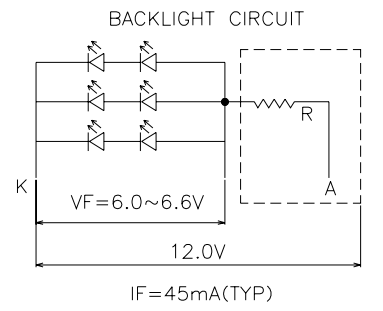
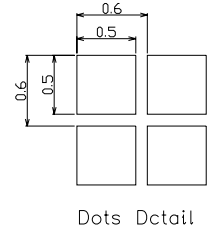
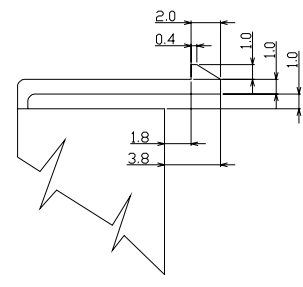
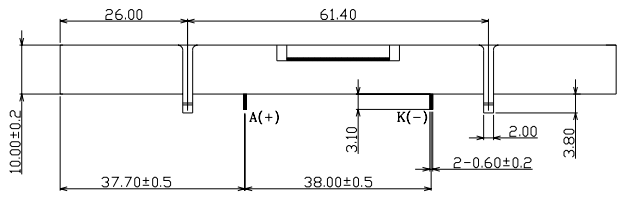
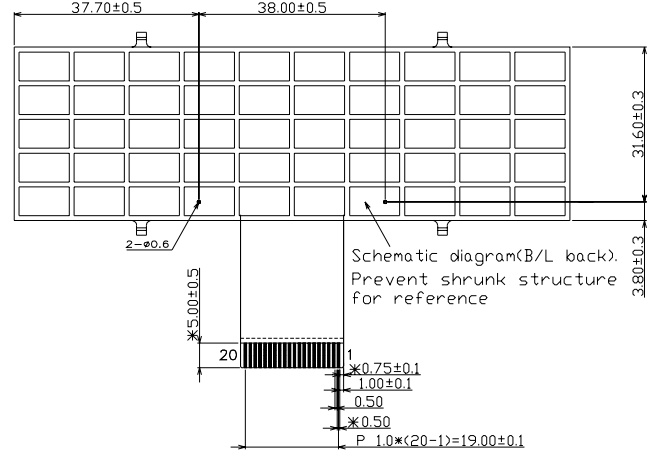
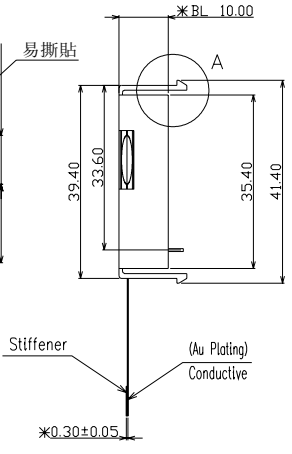
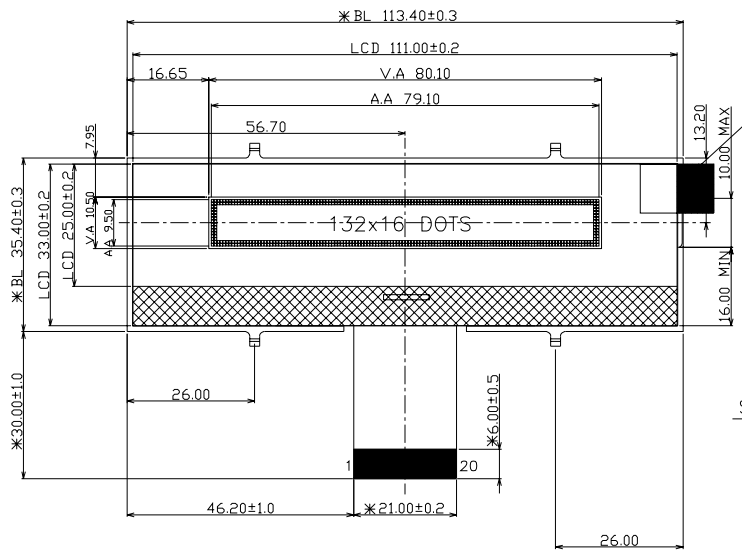

NOTE:  
 1. DISPLAY TYPE: VA  
 2. DRIVING METHOD: 1/16 DUTY, 1/4 BIAS  
 3. OPERATING VOLTAGE: VOP: 6.0V VDD: 3.3V  
 4. OPERATING TEMP: -10° ~ 80°C  
 5. STORAGE TEMP: -30° ~ 80°C  
 6. VIEWING DIRECTION: 12:00  
 7. POLARIZER MODE: TRANSMISSIVE/NEGATIVE  
 8. IC: ST7029  
 9. CONNECTION: FPC  
 10. BACKLIGHT COLOR: WHITE  
 11. DIMENSIONS ARE IN MILLIMETERS AND UNLESS OTHERWISE NOTED ARE ±0.30MM

REVISES		SUN-VIEW TECHNOLOGY CO., LTD						
DATE	CONTENT						PROJECTION	
10	增加重點尺寸標示	CUSTOM						第一角
		DRAWING BY	沈光娥	2018.11.21	ITEM	MD	UNITS	mm
		CHECKED BY			CODE	MD200217002	SCALE	
		APPROVED BY			MODEL	SVG132016AADC	SHEET	1 OF 2